

Gebrauchsanweisung | Instructions for use |
Mode d'emploi | Modo de empleo | Modalità d'uso

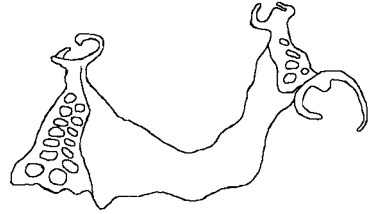

rema[®]
Exakt 

Phosphatgebundene Einbettmasse
Phosphate bonded investment material
Revêtement à liant phosphate
Revestimiento ligado con fosfato
Rivestimento a legante fosfatico

Sehr geehrte Kundin, sehr geehrter Kunde

Vielen Dank, dass Sie sich für ein Qualitätsprodukt aus dem Hause Dentaorium entschieden haben. Damit Sie dieses Produkt sicher und einfach zum größtmöglichen Nutzen für sich und die Patienten einsetzen können, muss diese Gebrauchsanweisung sorgfältig gelesen und beachtet werden.

In einer Gebrauchsanweisung können nicht alle Gegebenheiten einer möglichen Anwendung beschrieben werden. Bei Fragen und Anregungen können Sie sich gerne an unsere Hotline (+49 72 31/803-410) wenden.

Aufgrund der ständigen Weiterentwicklung unserer Produkte empfehlen wir Ihnen auch bei häufiger Verwendung des gleichen Produktes immer wieder das aufmerksame Durchlesen der jeweils aktuell beiliegenden bzw. im Internet unter www.dentaorium.com hinterlegten Gebrauchsanweisung.

Hersteller

Dentaorium GmbH & Co. KG | Turnstr. 31 | 75228 Ispringen | Germany

Sicherheitshinweise



Einbettmassen enthalten Quarz. Staub nicht einatmen! Gefahr von Lungenschäden (Silikose / Lungenkrebs).

Empfehlungen: Atemschutzmaske vom Typ FFP 2 – EN 149:2001 verwenden.

Beutel mit Schere aufschneiden und Staubbildung beim Einfüllen in den Anmischbecher vermeiden.

Leeren Beutel vor dem Zusammenknüllen mit Wasser ausspülen.

Staub am Arbeitsplatz nur feucht entfernen.

Um Staub beim Ausbetten zu vermeiden, die nach dem Guss völlig ausgekühlte Muffel in Wasser legen, bis sie durchfeuchtet ist.

Beim Abstrahlen Absaugung mit Feinstaubfilter verwenden.

Dear customer

Thank you for choosing a quality product from Dentaorium.

It is essential to read these instructions carefully and adhere to them to ensure safe, efficient use and ensure that you and your patients gain full benefit.

Instructions for use cannot describe every eventuality and possible application. In case of questions or ideas, please contact your local representative.

As our products are regularly upgraded, we recommend that you always carefully read the current instructions for use supplied with the product and stored in the internet at www.dentaorium.com, even though you frequently use the same product.

Manufacturer

Dentaorium GmbH & Co. KG | Turnstr. 31 | 75228 Ispringen | Germany

Safety information



Investments contain quartz. Avoid inhalation of dust as this may cause lung diseases (silicosis / lung cancer).

Wearing of face mask type FFP 2 – EN 149:2001 is recommended.

Open pouch with scissors and avoid dust development when pouring into mixing bowl.

Rinse empty pouch with water before disposal.

Remove dust from working area only with a wet cloth.

To avoid dust when devesting place ring into water until it is completely soaked after ring has reached room temperature.

When sandblasting use suction with fine dust filter.

FR

Chère Cliente, cher Client,

Nous vous remercions d'avoir choisi un produit de la qualité Dentaurum.

Pour une utilisation sûre et pour que vous et vos patients puissiez profiter pleinement des divers champs d'utilisation que couvre ce produit, nous vous conseillons de lire très attentivement son mode d'emploi et d'en respecter toutes les instructions.

Un mode d'emploi ne peut décrire de manière exhaustive tous les aspects à l'utilisation d'un produit. Si vous avez des questions, votre représentant sur place est à votre service pour y répondre et prendre note de vos suggestions.

En raison du développement constant de nos produits, nous vous recommandons, malgré l'utilisation fréquente du même produit, la relecture attentive du mode d'emploi actualisé ci joint (cf. également sur Internet sous www.dentaurum.com).

Fabricant

Dentaurum GmbH & Co. KG | Turnstr. 31 | 75228 Ispringen | Allemagne

Remarques concernant la sécurité



Les revêtements contiennent du quartz. Ne pas inhaler la poussière. Risque de lésions pulmonaires (silicose / cancer du poumon).

Recommandations : porter un masque de protection du type FFP 2 – EN 149:2001.

Ouvrir le sachet avec une paire de ciseaux.

Éviter le dégagement de poussière en remplissant le bol de mélange.

Rincer le sachet vide à l'eau, avant de le froisser.

Utiliser un chiffon humide, pour éliminer la poussière au poste de travail.

Afin d'éviter un dégagement de poussière lors du démoulage, plonger le cylindre, entièrement refroidi après la coulée, dans l'eau, jusqu'à ce qu'il soit imprégné.

Lors du sablage, utiliser un dispositif d'aspiration avec microfiltre.

Estimado cliente

Mucho le agradecemos que se haya decidido usted por un producto de calidad de la casa Dentaaurum. Para que usted pueda emplear este producto de forma segura y fácil y obtener los mayores beneficios posibles del mismo para usted y los pacientes, debe ser leído detenidamente y observado este modo de empleo.

En un modo de empleo no pueden ser descritos todos los datos y pormenores de una posible aplicación o utilización. En caso de preguntas, no dude en ponerse en contacto con su representante local.

Debido al permanente desarrollo de nuestros productos, recomendamos leer una y otra vez atentamente el modo de empleo actualizado anexo al producto o bien el modo de empleo que Ud. encontrará en internet en www.dentaaurum.com, aún cuando Ud. utilice el mismo producto frecuentemente.

Fabricante

Dentaaurum GmbH & Co. KG | Turnstr. 31 | 75228 Ispringen | Alemania

Advertencias de seguridad



Los revestimientos contienen polvo de cuarzo. ¡Evite la inhalación del polvo! Riesgo de dañar los pulmones (silicosis / cáncer de pulmón).

Recomendaciones: Ponerse mascarilla protectora tipo FFP 2 – EN 149:2001.

Cortar la bolsa con tijeras y evitar la formación de polvo al echarlo en la taza de mezcla.

Enjuagar con agua las bolsas vacías antes de plegarlas.

Quitar el polvo en el puesto de trabajo sólo con un paño húmedo.

Para evitar la formación de polvo al sacar de mufla, poner en agua el cilindro enfriado por completo después del colado hasta que esté bien mojado.

Al emplear el chorro de arena utilizar aspiración con filtro de polvo fino.

Egregio cliente

La ringraziamo per aver scelto un prodotto Dentaaurum di qualità.

Per utilizzare questo prodotto in modo sicuro ed efficiente, le consigliamo di leggere e seguire attentamente queste modalità d'uso.

Tenga presente che in ogni manuale d'uso non possono essere descritti tutti i possibili utilizzi dei materiali descritti e pertanto rimaniamo a Sua completa disposizione qualora necessitasse di ulteriori spiegazioni.

Tutti i prodotti che commercializziamo sono il risultato di nuovi sviluppi tecnologici e, quindi, le raccomandiamo di rileggere sempre attentamente le modalità d'uso allegate o quelle presenti nel sito www.dentaaurum.com anche in caso di ripetuto utilizzo dello spesso prodotto.

Fabricante

Dentaaurum GmbH & Co. KG | Turnstr. 31 | 75228 Ispringen | Alemania

Indicazioni di sicurezza



Il rivestimento contiene quarzo. Non inalare la polvere! Rischio di ledere i polmoni (silicosi / cancro ai polmoni).

Consiglio: indossare una mascherina di protezione tipo FFP 2 – EN 149:2001.



Aprire il sacchetto tagliando il bordo superiore con delle forbici ed evitare di inalare la polvere durante il versamento nel miscelatore.

Prima dello smaltimento, sciacquare il sacchetto vuoto sotto acqua corrente.

Asportare la polvere sul posto di lavoro solo con un panno umido.

Per evitare di inalare la polvere durante la smuffolatura, immergere il cilindro già freddo in acqua.

Durante la sabbiatura, utilizzare un filtro fine.

①  → 

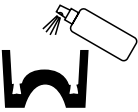

a silicone (rema[®]-Sil, ecosil)

b gel (Dublitop[®], Dublitop[®] micro, Dubliform, Duplikat)

② 

a Lubrofilm[®]

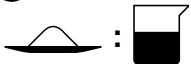
b -

③  : 

 3-4 min

20 °C : 22 °C
68 °F : 72 °F



④

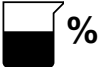

Liquid 100% **Liquid 50%** **Aqua dest.**

😊 😊 😞

100g:13ml **100g:13ml** **100g:14ml**

⑤



! clean

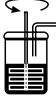

Vacuum



60 s



360 rpm

⑧



a silicone -

b gel



Hardener → 



5-10 s

⑨

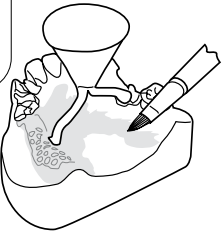

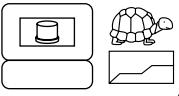

⑫

a



30 min



5-8 K/min

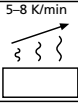

60 min



5-8 K/min

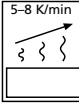

40 min



⑫

b

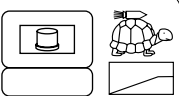

30 min



10 K/min

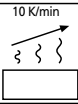



40 min

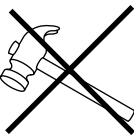

⑮







⑯



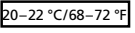



Al₂O₃

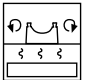

125-250 μm

6 

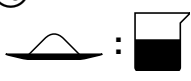

a silicone  30 min
 b gel  40 min

7 
 Model drying



a silicone  30 min, 100 °C / 212 °F
 b gel  40 min, 170-230 °C / 338-446 °F

10 

3-4 min 

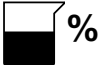

400 g : 56 ml  20 °C / 68 °F to 22 °C / 72 °F

11 

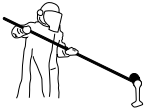
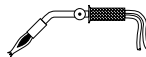
Liquid 100%	Liquid 50%	Aqua dest.
		
100g : 14 ml	100g : 14 ml	100g : 14 ml

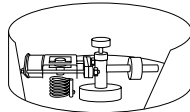
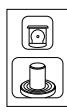
13 
 or

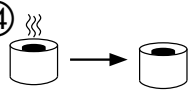
 or 

14  → 



 > 30 min



Pulver / Powder / Poudre / Polvo / Polvere

rema® Exakt	20 kg (100 x 200 g)	REF 105-021-00
	08 kg (20 x 400 g)	REF 105-008-00
	20 kg (50 x 400 g)	REF 105-020-00
	20 kg (8 x 2,5 g)	REF 105-020-80

Anmischflüssigkeit / Mixing liquid / Liquide de mélange / Líquido de mezcla /
Liquido di miscelazione

rema® Exakt	1 l	REF 105-501-00
Power Liquid	1 l	REF 105-502-00

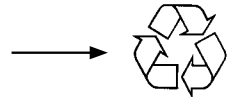
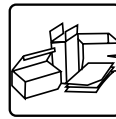
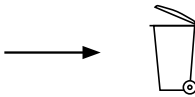
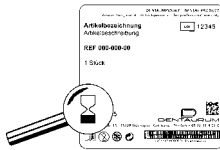
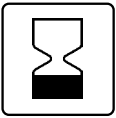

Werkstoffkennwerte / Material parameters / Caractéristiques /
Valores nominales / Specifiche del materiale

DIN EN ISO 15 912

Type 1, class 1

Erstarrungsbeginn / Initial setting time / Début de la solidification / Inizio del fraguado / Inizio indurimento	3 min 45 s *
Druckfestigkeit / Compressive strength / Résistance à la compression / Resistencia a la presión / Resistenza alla compressione	12 – 15 MPa *
Fließfähigkeit / Fluidity / Ecoulement libre / Fluides / Fluidità	110 – 120 mm *
Thermische Expansion / Thermal expansion / Expansion thermique / Expansión térmica / Espansione termica	1,00 % *

* Liquid 100 %

DE

Qualitätshinweise

Dentaurum versichert dem Anwender eine einwandfreie Qualität der Produkte. Der Inhalt dieser Gebrauchsanweisung beruht auf eigener Erfahrung. Der Anwender ist für die Verarbeitung der Produkte selbst verantwortlich. In Ermangelung einer Einflussnahme von Dentaurum auf die Verarbeitung besteht keine Haftung für fehlerhafte Ergebnisse.

EN

Quality information

Dentaurum ensures a faultless quality of the products manufactured by us. These recommendations are based upon our own experiences. The user himself is responsible for the processing of the products. Responsibility for failures cannot be taken, as we have no influence on the processing on site.

FR

Remarques au sujet de la qualité

Dentaurum garantit à l'utilisateur une qualité irréprochable des produits. Le contenu du présent mode d'emploi repose sur notre propre expérience et demeure sans engagement. L'utilisateur est personnellement responsable de la mise en œuvre des produits. N'ayant aucune influence sur leur manipulation par ce dernier, Dentaurum ne peut être tenu pour responsable de résultats inexacts.

ES

Observaciones sobre la calidad

Dentaurum garantiza al usuario una calidad impecable de los productos. Las indicaciones en este modo de empleo se basan en experiencias propias. El usuario mismo tiene la responsabilidad de trabajar correctamente con los productos. No respondemos por resultados incorrectos, debido a que Dentaurum no tiene influencia alguna en la forma de utilización por el usuario.

IT

Indicazioni di qualità

La Dentaurum assicura la massima qualità dei prodotti fabbricati. Il contenuto di queste modalità d'uso è frutto di nostre personali esperienze e pertanto l'utilizzatore è responsabile del corretto impiego del prodotto. In mancanza di condizionamenti di Dentaurum sull'utilizzo del prodotto da parte dell'utente, non sussiste alcuna responsabilità oggettiva per eventuali insuccessi.

Dentaurum

Germany | Benelux | España | France | Italia | Switzerland | Australia | Canada | USA
and in more than 130 countries worldwide.



DENTAURUM
QUALITY
WORLDWIDE
UNIQUE

- ➔ Informationen zu Produkten und Serviceleistungen finden Sie unter www.dentaurum.com
- ➔ For more information on our products and services, please visit www.dentaurum.com
- ➔ Vous trouverez toutes les informations sur nos produits et services sur www.dentaurum.com
- ➔ Descubra nuestros productos y servicios en www.dentaurum.com
- ➔ Informazioni su prodotti e servizi sono disponibili nel sito www.dentaurum.com

Stand der Information | Date of information | Mise à jour |
Fecha de la información | Data dell'informazione: 09/16

Änderungen vorbehalten | Subject to modifications | Sous réserve de modifications |
Reservado el derecho de modificación | Con riserva di apportare modifiche

D
DENTAURUM